

D-Series High Power Laser Diode Module

M878.6±0.5-120-F200/22-DK



Han's TianCheng Semiconductor Co.,Ltd., founded in November 2011 in Beijing Development Area, is a subsidiary company of Han's Laser. Han's TianCheng has advanced research, technological infrastructure and experience in the development and production of diode lasers with self-developed technology, especially in fiber coupled laser modules. Han's TianCheng provides high power semiconductor laser products which are widely used in the fields such as material processing, diode-pumped solid-state pumping, fiber laser pumping, laser display, medical application and scientific research

Han's TianCheng dedicates to the development of high brightness fiber coupled diode laser modules with output power from ten to hundreds of watts, and the wavelength from 405nm to 1550nm. We can also provide special wavelength and multi-wavelength products, and other customizing products and OEM services.

Features:

- ◆ High output power of 120W
- ◆ 878.6nm wavelength locked
- ◆ 200 μ m core 0.22NA multimode optical fiber
- ◆ Narrow line width <0.5nm

Applications:

- ◆ Fiber laser pumping
- ◆ Direct diode laser applications

Typical Device Performance (25°C)

	Symbol	Typical Value	Unit
Optical			
CW Output Power	P_{op}	120	W
Center Wavelength	λ	878.6±0.5	nm
Spectral Width (90% of Power)	$\Delta\lambda$	<0.5	nm
Wavelength Shift with Temperature	$\Delta\lambda/\Delta T$	0.02	nm / °C
Wavelength Shift with Current	$\Delta\lambda/\Delta I_{op}$	0.05	nm / A
Feedback Protection (1030-1100nm)	FP	>40	dB
Electrical			
Threshold Current	I_{th}	0.7	A
Operating Current	I_{op}	10	A
Operating Voltage	V_{op}	31	V
Slope Efficiency	η_{es}	14	W / A
Power Conversion Efficiency	η_{ep}	42	%
Fiber*			
Fiber Core Diameter	d_{core}	200	μm
Fiber Cladding Diameter	d_{clad}	220	μm
Fiber Buffer Diameter	d_{buffer}	500	μm
Numerical Aperture	NA	0.22	-
Fiber Length	L	1-5	m

* Customized fiber and connector available.

Absolute Ratings

Parameter	Min	Max	Unit
Operating Temperature	15	40	°C
Operating Relative Humidity	-	75	%
Cooling mode		水冷 (25°C)	
Storage Temperature	-20	80	°C
Storage Relative Humidity	-	90	%
Lead Soldering Temperature, 10 s max	-	250	°C

Characteristics of 878.6nm-120W laser diode module (25°C)

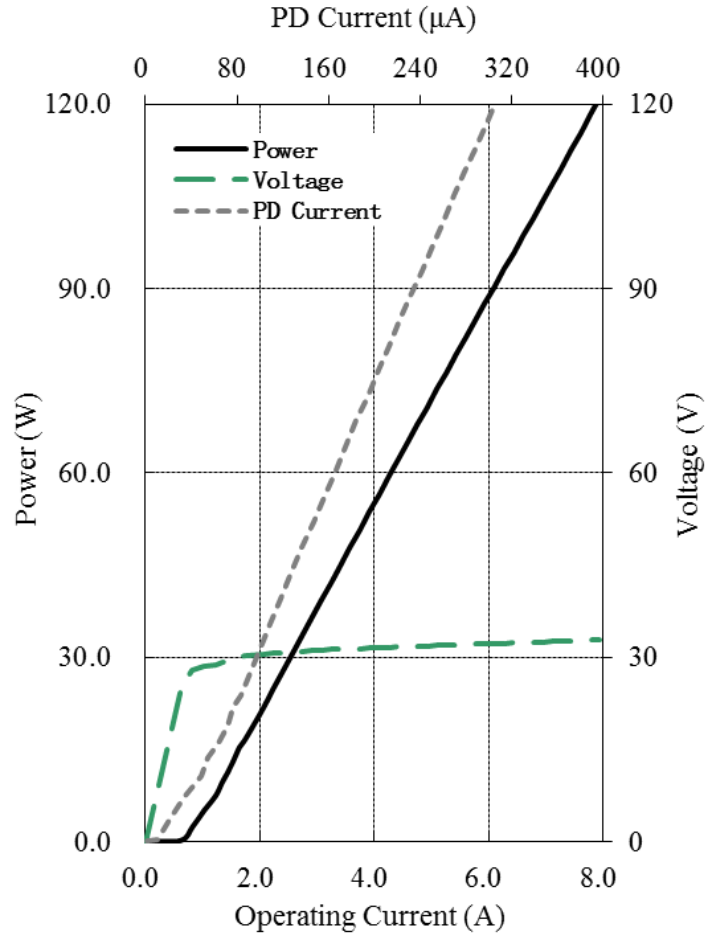

Typical spectrum of 878.6nm-120W laser diode module (25°C)

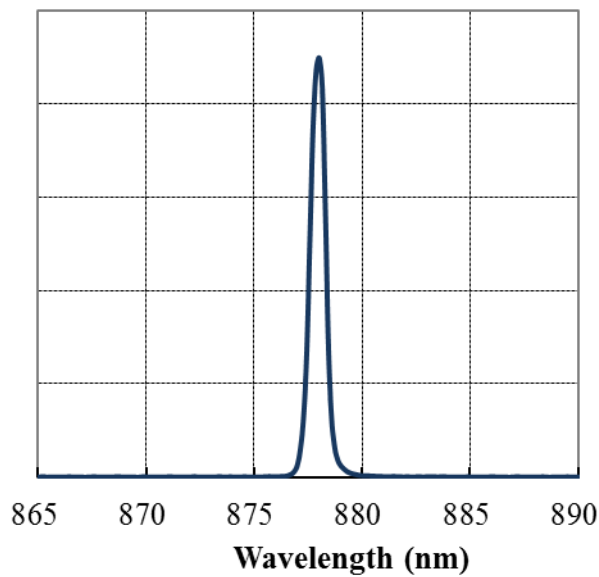

Package Dimensions (mm)

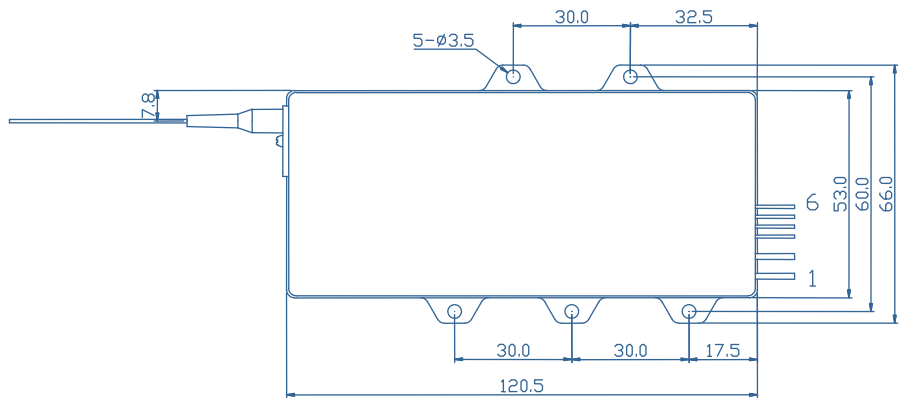
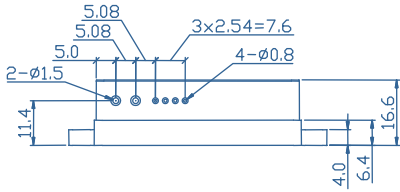

Pin-Out Assignment	
Pin	Function
1	LD (+)
2	LD (-)
3	PD(N)
4	PD(P)
5	Thermistor
6	Thermistor

Type Definition

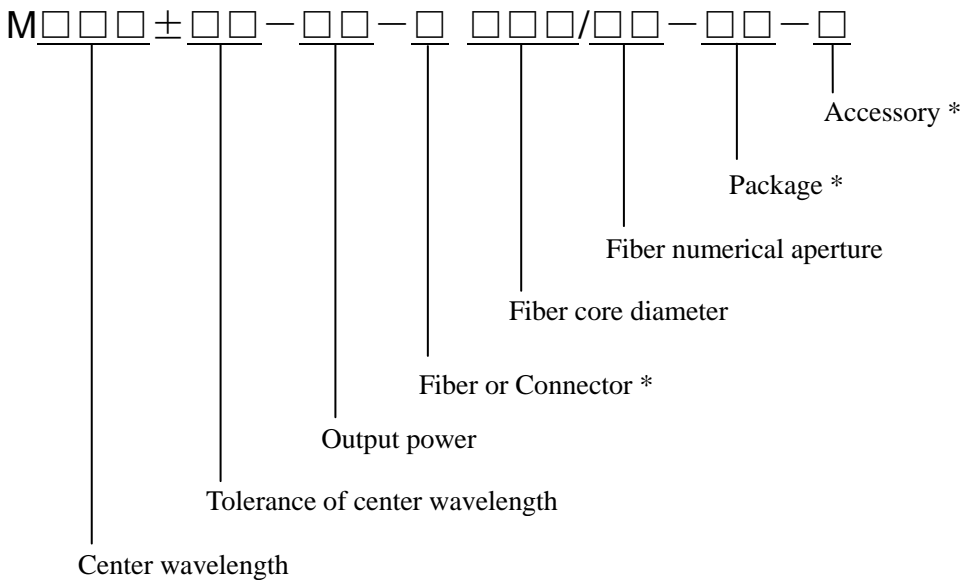

* Accessory: T – TE cooler, A – Aiming laser, P – Monitor photodiode, K – Fiber connector detector

* Fiber or Connector: F – Fiber output, D – Detachable connector

