

## C-Series High Power Laser Diode Module

### M915±10-80-F105/22-CK

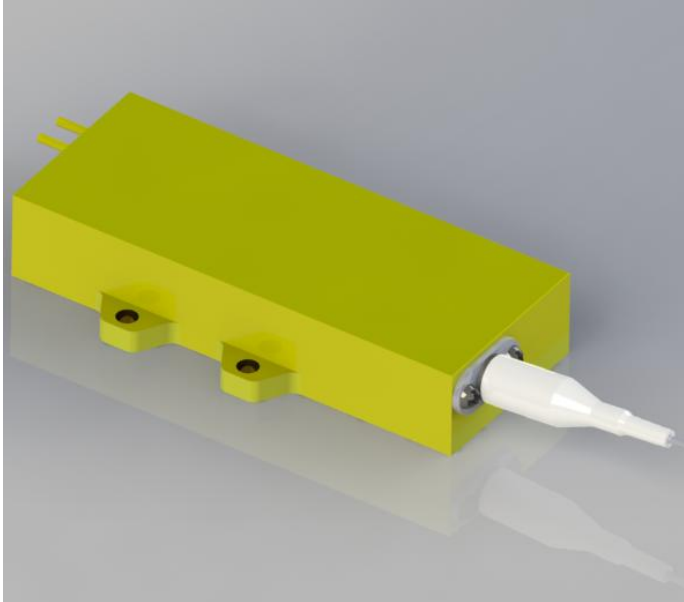

Han's TianCheng Semiconductor Co.,Ltd., founded in November 2011 in Beijing Development Area, is a subsidiary company of Han's Laser. Han's TianCheng has advanced research, technological infrastructure and experience in the development and production of diode lasers with self-developed technology, especially in fiber coupled laser modules. Han's TianCheng provides high power semiconductor laser products which are widely used in the fields such as material processing, diode-pumped solid-state pumping, fiber laser pumping, laser display, medical application and scientific research

Han's TianCheng dedicates to the development of high brightness fiber coupled diode laser modules with output power from ten to hundreds of watts, and the wavelength from 635nm to 1550nm. We can also provide special wavelength and multi-wavelength products, and other customizing products and OEM services.

#### Features:

- ◆ High output power of 80W
- ◆ 105 $\mu$ m core 0.22NA multimode optical fiber
- ◆ 95% Light within 0.16NA
- ◆ Fiber laser feedback protection

#### Applications:

- ◆ Fiber laser pumping
- ◆ Material processing
- ◆ Direct diode laser applications

## Typical Device Performance (25°C)

	Symbol	Typical Value	Unit
<b>Optical</b>			
CW Output Power	$P_{op}$	80	W
Center Wavelength	$\lambda$	915±10	nm
Spectral Width (90% of Power)	$\Delta \lambda$	<6.0	nm
Wavelength Shift with Temperature	$\Delta \lambda / \Delta T$	0.3	nm / °C
Feedback Protection (1030-1100nm)	FP	>40	dB
Light within 0.16NA	-	95%	-
<b>Electrical</b>			
Threshold Current	$I_{th}$	0.7	A
Operating Current	$I_{op}$	11.7	A
Operating Voltage	$V_{op}$	14.0	V
Slope Efficiency	$\eta_{es}$	7.4	W / A
Power Conversion Efficiency	$\eta_{ep}$	48.5	%
<b>Fiber*</b>			
Fiber Core Diameter	$d_{core}$	105	μm
Fiber Cladding Diameter	$d_{clad}$	125	μm
Fiber Buffer Diameter	$d_{buffer}$	250	μm
Numerical Aperture	NA	0.22	-
Fiber Length	$L_f$	1.0	m
Fiber connector	-	-	-

\* Customized fiber and connector available.

## Absolute Ratings

	Min	Max	Unit
Operating Temperature	10	40	°C
Operating Relative Humidity	-	75	%
Storage Temperature	-20	80	°C
Storage Relative Humidity	-	90	%
Lead Soldering Temperature, 10 s max	-	250	°C

**Characteristics of 915nm-80W laser diode module (25°C)**

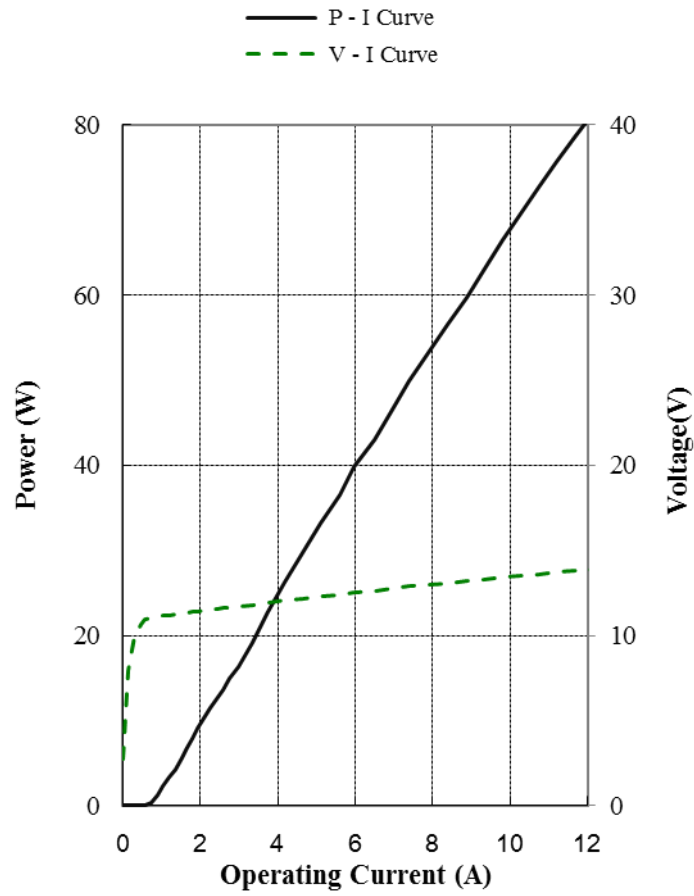

**Typical spectrum of 915nm-80W laser diode module (25°C)**

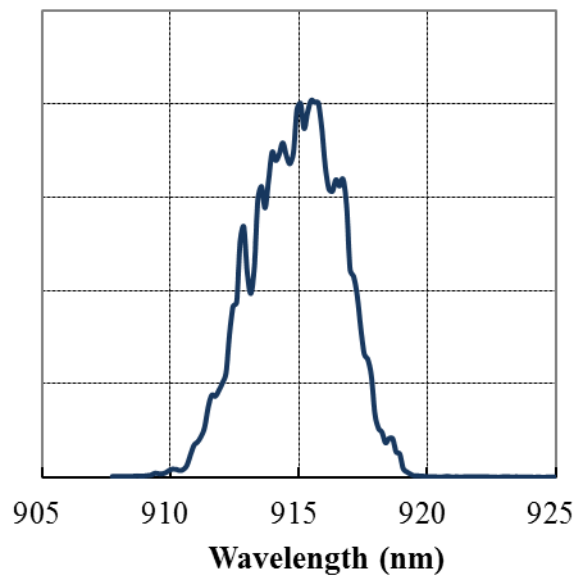

**Package Dimensions (mm)**

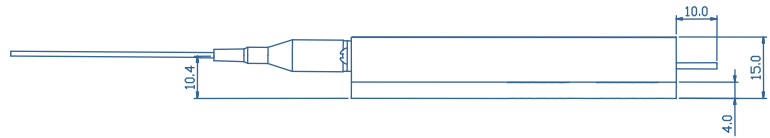
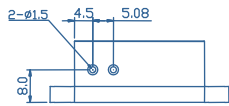

Pin-Out Assignment	
Pin	Function
1	LD (+)
2	LD (-)

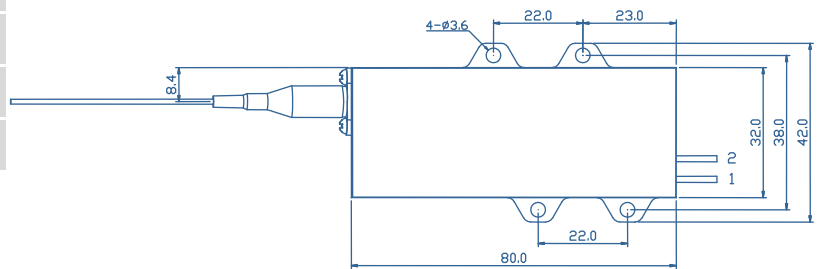

**Type Definition**

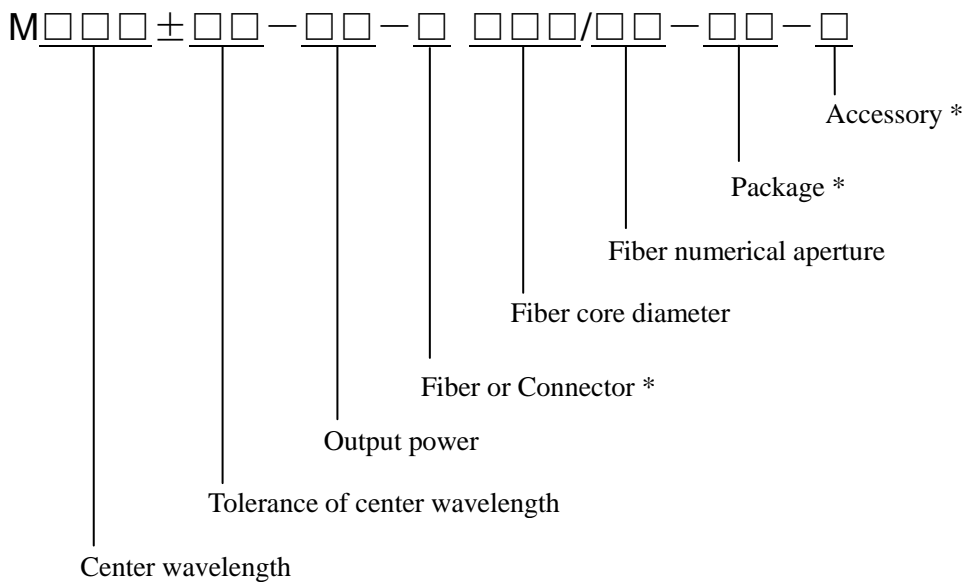

\* Accessory: T – TE cooler, A – Aiming laser, P – Monitor photodiode, K – Fiber connector detector

\* Package: R2, T1, T2, T3, T4, T4S, T4T, T6, G4, C1, CD, D1.....

\* Fiber or Connector: F – Fiber output, D – Detachable connector

